

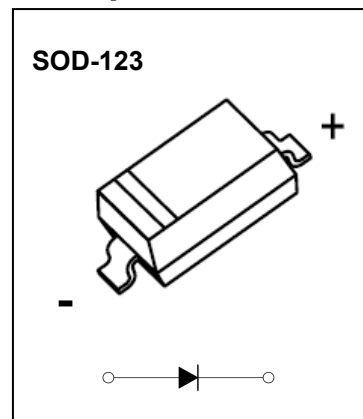

SOD-123 Plastic-Encapsulate Diodes

FEATURES

- Lead Free Finish/RoHS Compliant
- Extremely Low Thermal Resistance
- For Surface Mount Application and High Current Capability

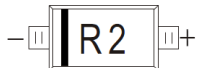
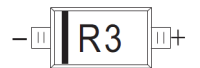
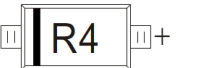
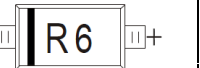

MARKING:

MBR0520 :R2	MBR0530 :R3	MBR0540 :R4	MBR0560 :R6	MBR0580 :R8
				

Maximum Ratings @T_a=25°C

Parameter	Symbol	MBR	MBR	MBR	MBR	MBR	Unit
		0520	0530	0540	0560	0580	
Maximum recurrent peak reverse voltage	V _{RRM}	20	30	40	60	80	V
Maximum RMS voltage	V _{RMS}	14	21	28	42	56	
Mean rectifying current	I _O	0.5					A
Non-repetitive Peak forward surge current @t=8.3ms	I _{FSM}	5.5					A
Power Dissipation	P _D	410					mW
Thermal Resistance Junction to Ambient	R _{θJA}	244					°C/W
Junction temperature	T _J	125					°C
Storage temperature	T _{stg}	-55~+150					°C

ELECTRICAL CHARACTERISTICS
 $T_a=25^{\circ}\text{C}$ unless otherwise specified

Parameter	Symbol	Min.	Typ.	Max.	Unit	Conditions
Forward voltage						
MBR0520	V_F			0.45	V	$I_F=500\text{mA}$
MBR0530				0.55		
MBR0540				0.55		
MBR0560				0.70		
MBR0580				0.80		
Reverse current						
MBR0520	I_R			80	μA	$V_R=20\text{V}$
MBR0530						$V_R=30\text{V}$
MBR0540						$V_R=40\text{V}$
MBR0560						$V_R=60\text{V}$
MBR0580						$V_R=80\text{V}$
Capacitance between terminals	C_T		30		pF	$V_R=4\text{V}, f=1\text{MHZ}$

Typical Characteristics

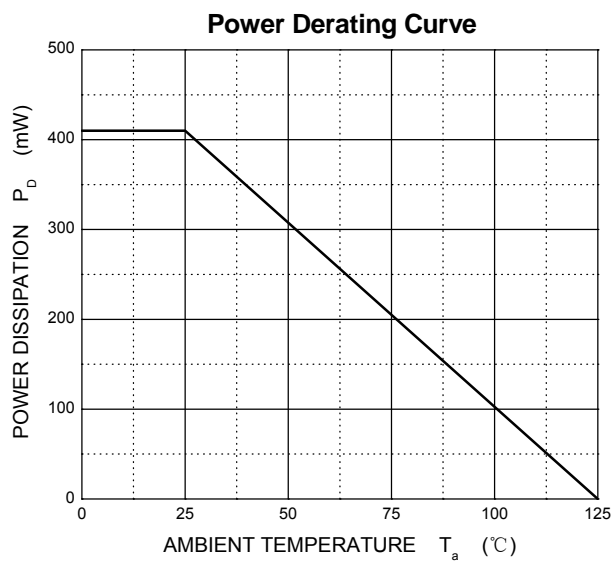
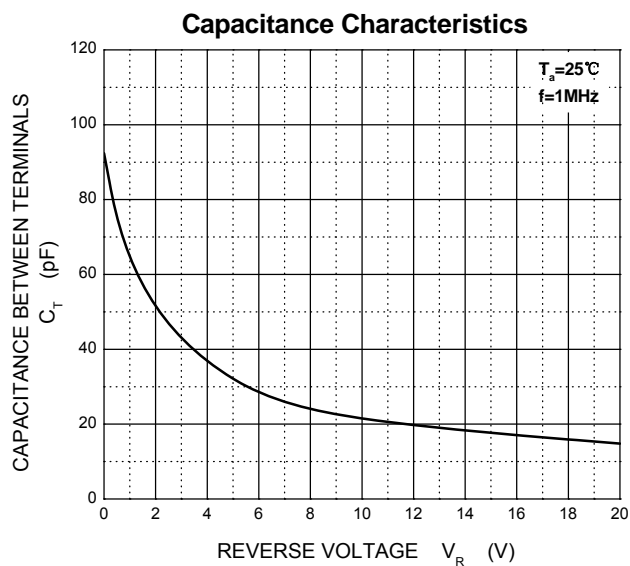
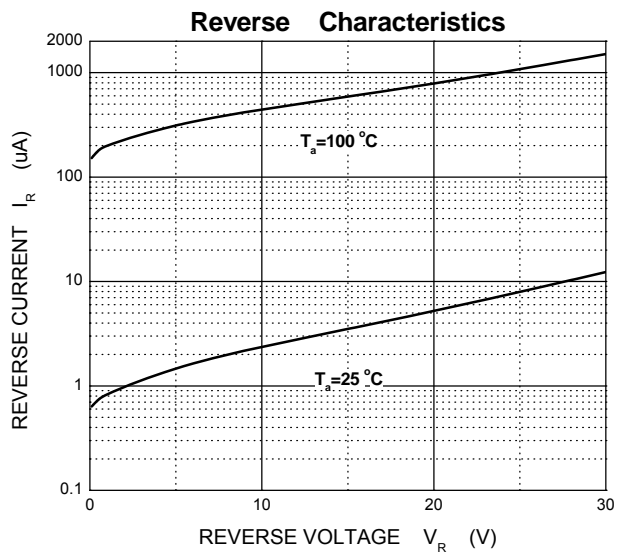
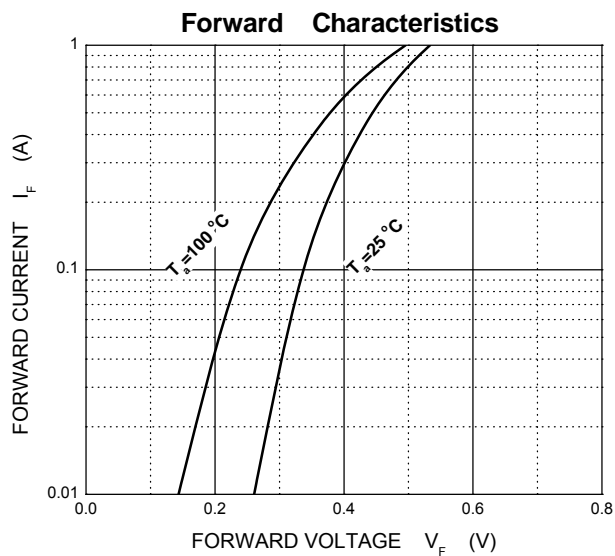

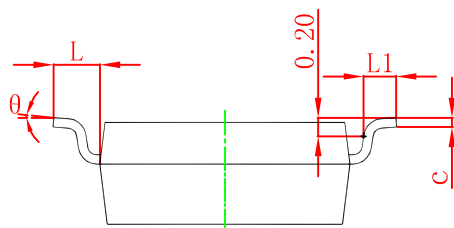
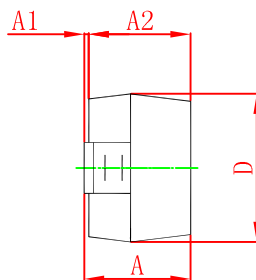
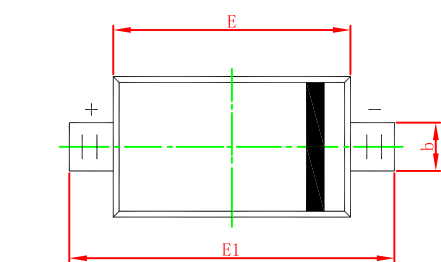

Symbol	Dimensions In Millimeters		Dimensions In Inches	
	Min	Max	Min	Max
A	1.050	1.250	0.041	0.049
A1	0.000	0.100	0.000	0.004
A2	1.050	1.150	0.041	0.045
b	0.450	0.650	0.018	0.026
c	0.080	0.150	0.003	0.006
D	1.500	1.700	0.059	0.067
E	2.600	2.800	0.102	0.110
E1	3.550	3.850	0.140	0.152
L	0.500 REF		0.020 REF	
L1	0.250	0.450	0.010	0.018
θ	0°	8°	0°	8°

SOD-123 Suggested Pad Layout

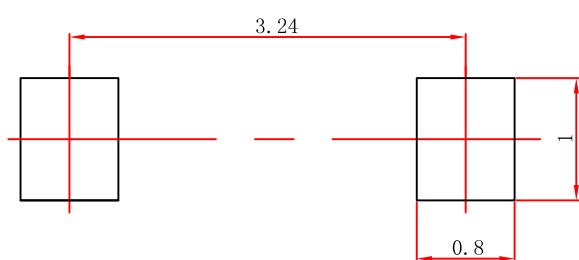

- Note:**
1. Controlling dimension: in millimeters.
 2. General tolerance: ± 0.05 mm.
 3. The pad layout is for reference purposes only.